

Work happily



V1.3

naggura'swop

naggura.com

Our products

 Podo



The Swop P3 Pro Podo is a 3-engine podiatry bed of optimum stability and ultra-compact frame.

Wood, Metal or Pmma



Collections

Nordic
METAL

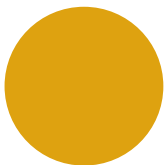

Yellow



Blue

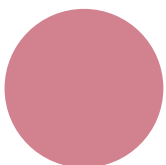

Pink

Foll
METAL



Ash

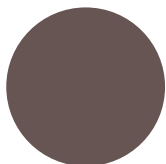

Clay

Iron
METAL

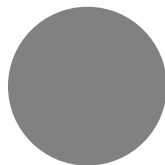

Inox

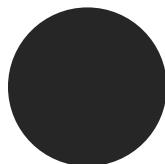

Black

Om
WOOD



Oak



Wenge

Techno
PMMA



Fluor

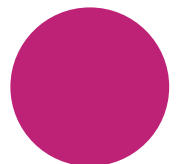

Fuxia



Ice

SWOP P3 PRO PODO



Dimensions

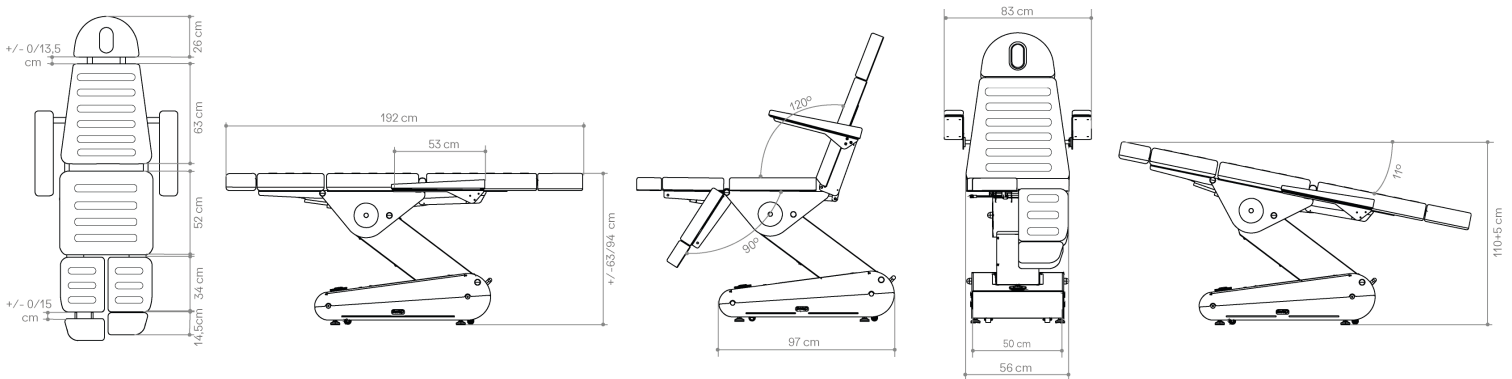

General Specifications

MOTORS
3 engines

DIMENSIONS (LENGTH X WIDTH)
192 x 83 cm

HEIGHT (MIN. AND MAX.)
63/94 cm

WEIGHT
105 kg

THICKNESS
10 cm

DENSITY
40 kg/m³

LIFTING CAPACITY
175 kg

OPERATION
**Hand controller (included)/
Foot controller (optional)**

POWER SUPPLY
230 V - 50/60 Hz

MAX. INTENSITY
2 A

ELECTRIC MOTOR
6.000 N

WARRANTY
**2 years on table and
upholstery**

CUSHION

**Naggura Skin upholstery:
100% vinyl compound in
white or grey.**

**Superior abrasion resis-
tance: >250.000 cycles.
Protection against germs
and UV rays.**

Nuestros Productos

 Podo



La Swop P3 Pro Podo es una camilla eléctrica de 3 motores con una estabilidad óptima y una estructura ultra-compacta

Madera, Metal o Pmma



Colecciones

Nordic
METAL

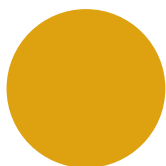

Yellow

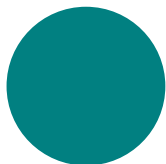

Blue

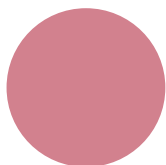

Pink

Foll
METAL



Ash

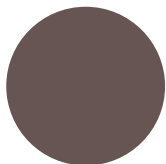

Clay

Iron
METAL

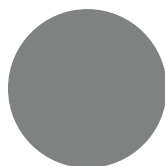

Inox

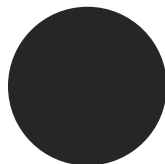

Black

Om
MADERA



Oak



Wenge

Techno
PMMA



Fluor

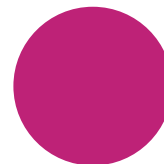

Fuxia



Ice

SWOP P3 PRO PODO



Dimensiones

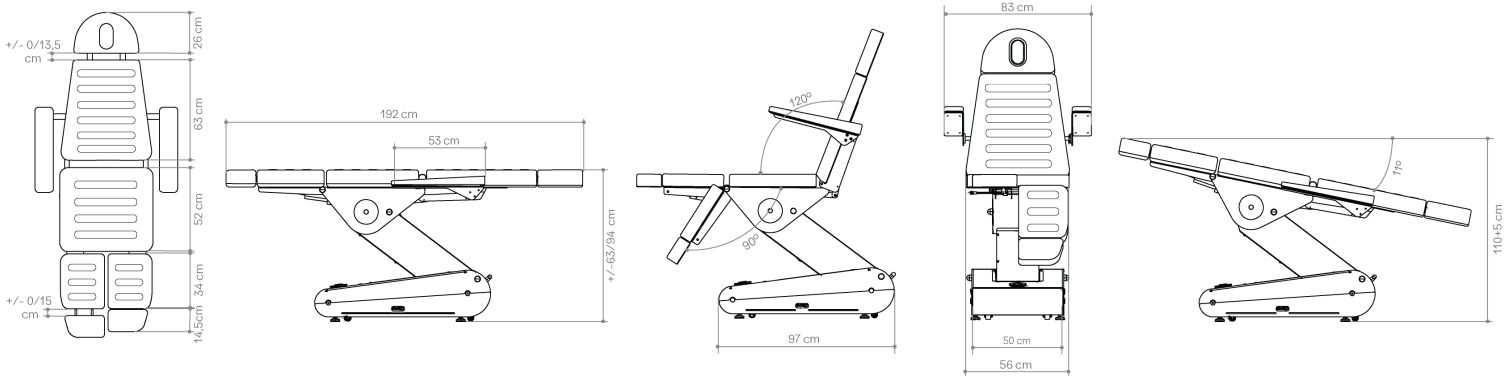

Características técnicas

MOTORES
3 motores

DIMENSIONES (LARGO X ANCHO)
192 x 83 cm

ALTURA (MÍNIMA Y MÁXIMA)
63/94 cm

PESO
105 kg

ESPESOR
10 cm

DENSIDAD
40 kg/m³

CAPACIDAD DE CARGA
175 kg

FUNCIONAMIENTO
Mando (incluido)/ Pedal
(opcional)

FUENTE DE ALIMENTACIÓN
230 V - 50/60 Hz

POTENCIA MÁXIMA
2 A

MOTOR ELÉCTRICO
6.000 N

GARANTÍA
2 años (camilla y tapizado)

TAPIZADO

Tapizado con Naggura Skin: 100% Mezcla de vinilo en blanco o gris.

Resistencia a la abrasión: >250.000 ciclos. Protección contra gérmenes y rayos UV.

I nostri prodotti

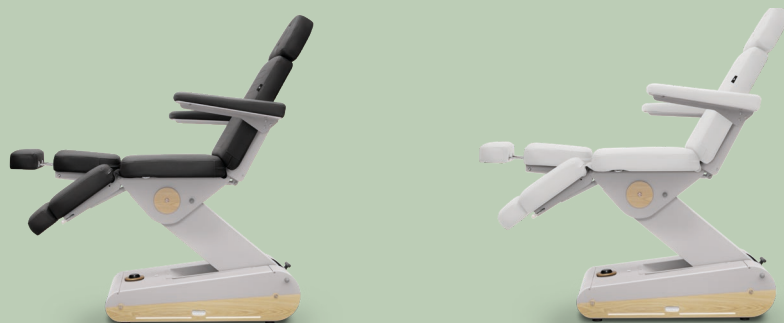

La SWOP P3 Pro Podo è un lettino elettrico di 3 motori con un'ottima stabilità e un telaio ultra compatto.

Legno, Metallo o Pmma

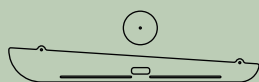

Collezioni

Nordic
METALLO

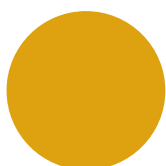

Yellow

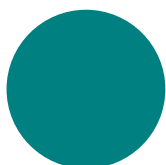

Blue

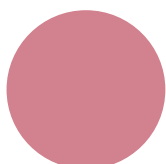

Pink

Foll
METALLO



Ash

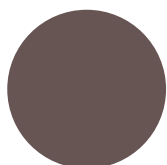

Clay

Iron
METALLO

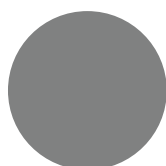

Inox

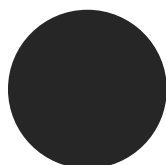

Black

Om
LEGNO



Oak



Wenge

Techno
PMMA



Fluor

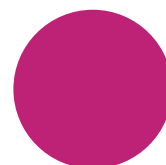

Fuxia



Ice

SWOP P3 PRO PODO



Dimensioni

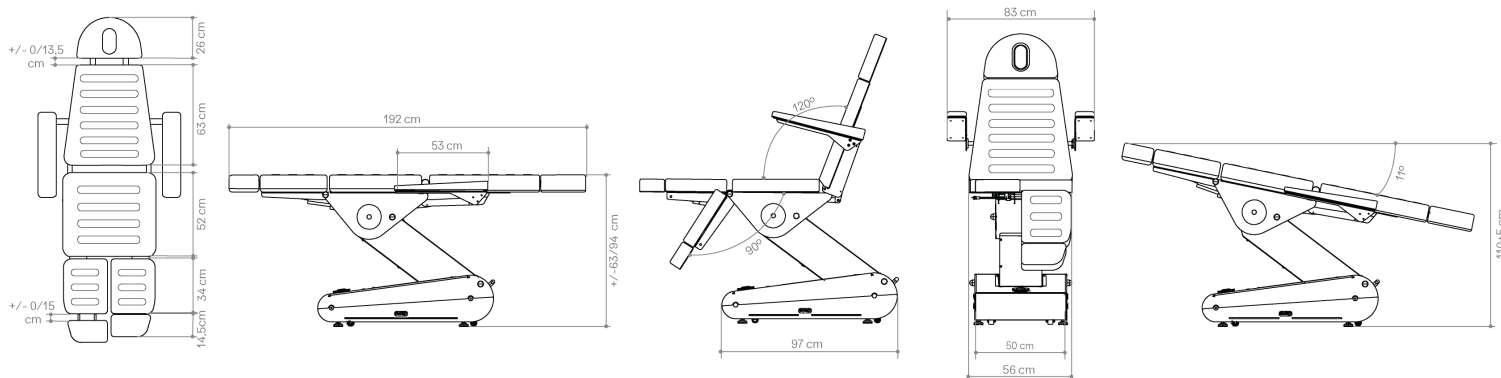

Caratteristiche tecniche

MOTORI
3 motori

DIMENSIONI (LUNGHEZZA X LARGHEZZA)
192 x 83 cm

ALTEZZA (MINIMA E MASSIMA)
63/94 cm

PESO
105 kg

SPESSORE
10 cm

DENSITÀ
40 kg/m³

CAPACITÀ DI CARICO
175 kg

FUNZIONAMENTO
**Telecomando (incluso)/
Pedaliera (opzionale)**

ALIMENTAZIONE ELETTRICA
230 V - 50/60 Hz

POTENZA MASSIMA
2 A

MOTORE ELETTRICO
6.000 N

GARANZIA
2 anni sul lettino e il rivestimento

RIVESTIMENTO

**Rivestimento Naggura
Skin: 100% Mix vinilico in
bianco o grigio.**

**Resistenza all'abrasione:
>250.000 cicli. Protezione
contro germi e raggi UV.**

Nos produits

 Podo



Swop P3 Pro Podo est un fauteuil de podologie à 3 moteurs avec une stabilité optimale et un châssis ultra-ferme.

Bois, Métal ou PMMA



Collections

Nordic
MÉTAL

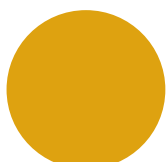

Yellow

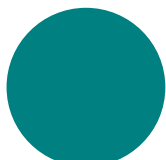

Blue

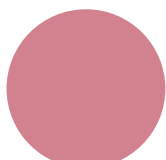

Pink

Foll
MÉTAL

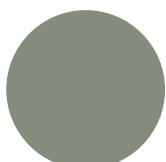

Ash

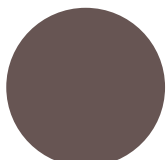

Clay

Iron
MÉTAL

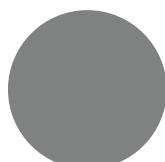

Inox

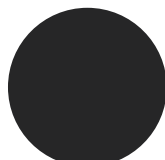

Black

Om
BOIS



Oak



Wenge

Techno
PMMA



Fluor

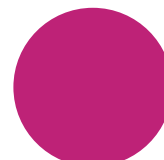

Fuxia



Ice

SWOP P3 PRO PODO



Dimensions

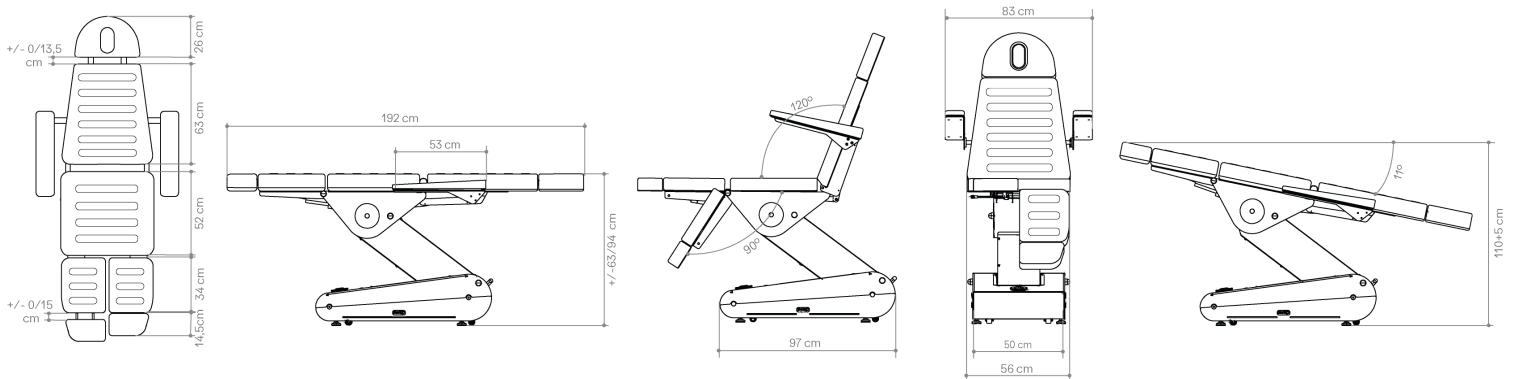

Spécifications Générales

MOTEURS
3 moteurs

DIMENSIONS (LONGUEUR X LARGEUR)
192 x 83 cm

HAUTEUR (MIN. ET MAX.)
63/94 cm

POIDS
105 kg

ÉPAISSEUR
10 cm

DENSITÉ
40 kg/m³

CAPACITÉ DE CHARGE
175 kg

FONCTIONNEMENT
Télécommande à main
(comprise)/Commande à
pied (option)

ALIMENTATION
230 V - 50/60 Hz

INTENSITÉ MAX.
2 A

VÉRIN ÉLECTRIQUE
6.000 N

GARANTIE
2 ans sur la table et le revê-
tement

MATELAS

Revêtement avec Naggura
Skin : 100% composé de
vinyle en blanc ou gris.

Résistance à l'abrasion :
>250.000 cycles. Protection
contre germes et rayons
UV.

Unsere Produkte

 Podo



Die Swop P3 Pro Podo ist eine dreimotorige Fußpflegeliege mit optimaler Stabilität und superkompaktem Gestell.

Holz, Metall oder Pmma



Kollektionen

Nordic
METALL

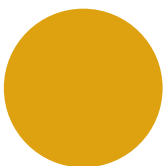

Yellow

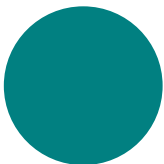

Blue

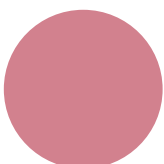

Pink

Foll
METALL

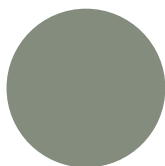

Ash

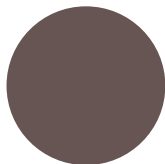

Clay

Iron
METALL

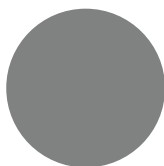

Inox

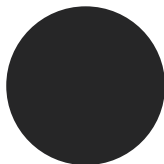

Black

Om
HOLZ



Oak



Wenge

Techno
PMMA



Fluor

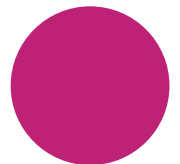

Fuxia



Ice

SWOP P3 PRO PODO



Abmessungen

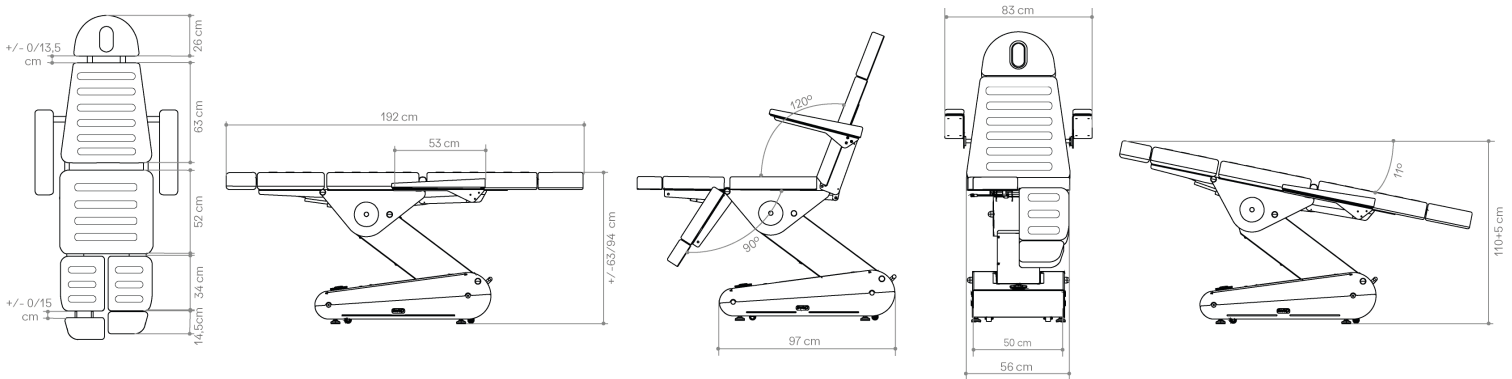

Technische Angaben

MOTOREN
3 Motoren

ABMESSUNGEN (LÄNGE X BREITE)
192 x 83 cm

HÖHE (MIN. UND MAX.)
63/94 cm

GEWICHT
105 kg

POLSTERDICKE
10 cm

DICHTE
40 kg/m³

BELASTBARKEIT
175 kg

BEDIENUNG
Handfernbedienung (serienmäßige Ausstattung)/
Fußfernbedienung (optional)

STROMVERSORGUNG
230 V - 50/60 Hz

MAX. INTENSITÄT
2 A

ELEKTRISCHER MOTOR
6.000 N

GARANTIE
2 Jahre auch auf Polsterbezug

POLSTERUNG

Naggura Skin Polsterbezug: 100 % Vinyl-Mischung in Weiß oder Grau.

Abriebfestigkeit: >250.000 Zyklen. Schutz vor Keimen und UV-Strahlen.

Onze producten

 Podo



De Swop P3 Pro Podo is een podologie stoel met 3 motoren en heeft een ultra-compact en uiterst stabiel frame.

Hout, metaal of Pmma



Collectie paneeltjes

Nordic
METAAL

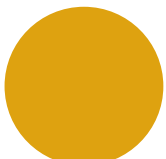

Yellow

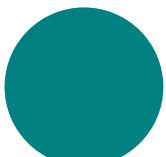

Blue

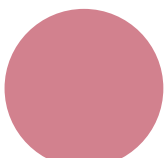

Pink

Foll
METAAL

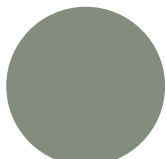

Ash

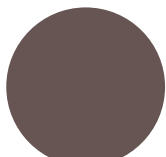

Clay

Iron
METAAL

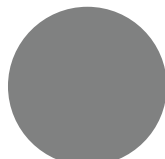

Inox

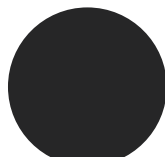

Black

Om
HOUT



Oak



Wenge

Techno
PMMA



Fluor



Fuxia



Ice

SWOP P3 PRO PODO



Afmetingen en instelmogelijkheden

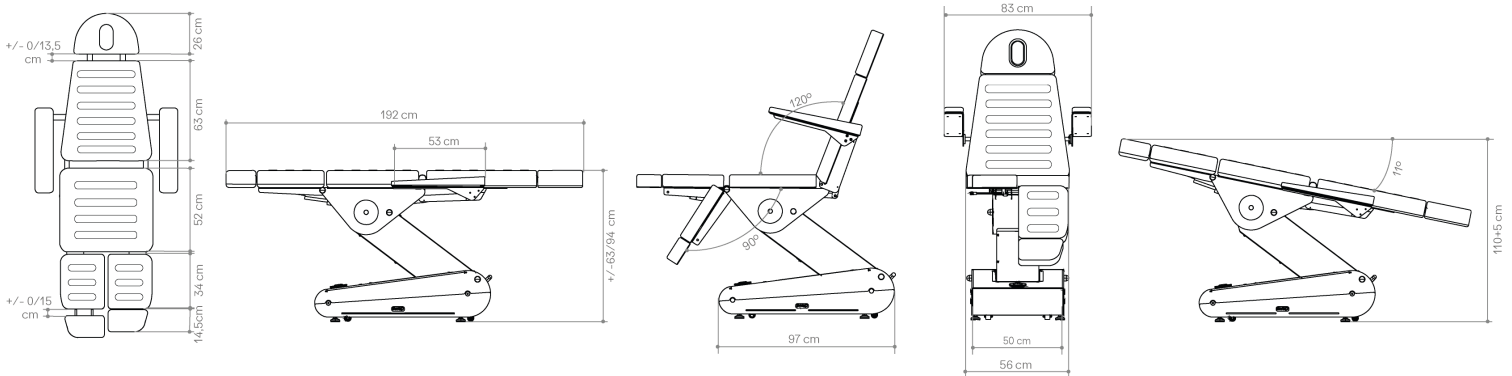

Algemene Specificaties

MOTOREN

3 motoren (hoogte, rugleun-
ning, inclinatie zitdeel)

AFMETINGEN (LENGTE-BREEDTE)

192 x 83 cm

HOOGTE (MIN. AND MAX.)

63/94 cm

GEWICHT

105 kg

DIKTE KUSSENS

10 cm

POLSTERING

40 kg/m³ (zacht)

MAXIMALE DYNAMISCHE BELASTING

175 kg

BEDIENING

Handschakelaar (inbe-
grepen)/ Voetschakelaar
(optioneel). Gescheiden
beendelen, separaat in te
stellen met gasveer.

STROOMVOORZIENING

230 V - 50/60 Hz

MAX. STROOMOPNAME

2 A

ELEKTRISCHE MOTOR HOOG/LAAG

6.000 N

STANDAARD TOEBEHOREN

Set houten paneeltjes: OAK

GARANTIE

3 jaar op bank en kunstleer

BEKLEDING

Naggura Skin bekleding:
100% vinyl samenstelling in
wit of graphite.

Een slijtvastheid van het
kunstleer is maar liefst
250K en beschermt tegen
bacteriën en UV stralen.